



Nelson Electric Supply Company, Inc.

262.635.5050 • 800.80.NELSON • www.nelson-electric.com



Introducing SMC's MultiTool: ETECH

www.smcetech.com



- The **free** web application to select, size, and build pneumatic automation products.
- Generate and download pdfs, 2D and 3D CAD drawings and models.
- Save your work on-line allowing you to share information with others or quickly return to previously saved products and drawings.



Nelson's Pneumatics Engineer is Here for You.

Peter Landgraf is available to demonstrate the capabilities and ease of use of ETECH.

He can also assist you with *all* your pneumatics needs.

plandgraf@nelson-electric.com

262.504.3638

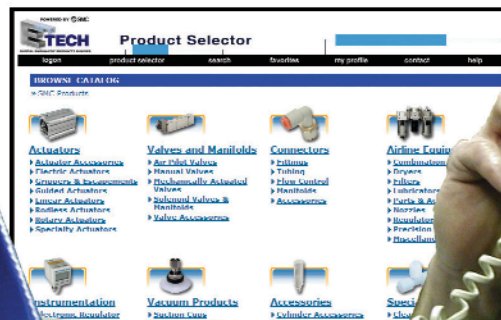

Some of the many things you can do on www.smctech.com (actual screen captures).

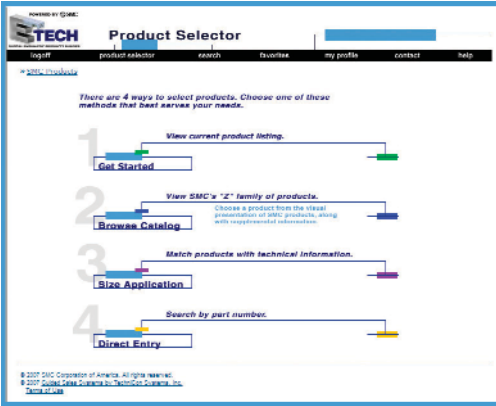

ETECH features four powerful, dynamic ways to select products.

Choose a product from the visual presentation of SMC products, along with supplemental information.

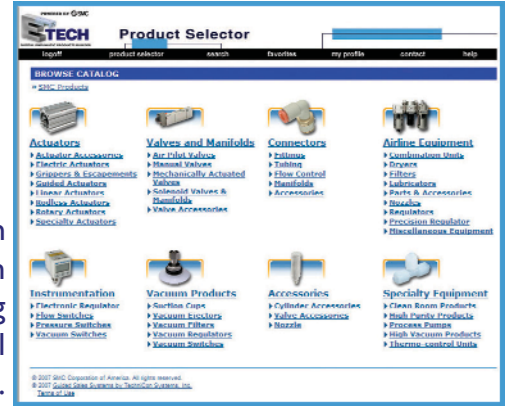

Build a part number step by step.

Select products by using an industry specific "model" to define operating conditions and load parameters.

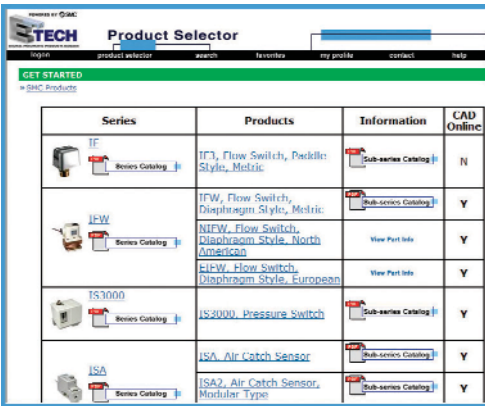
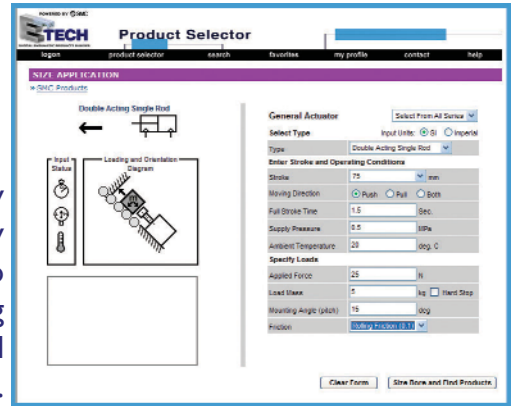

PDFs galore. Download catalog pages for all SMC's parts.

With your own account you can save favorites for quick access later, email them, and download 2D and 3D CAD files.

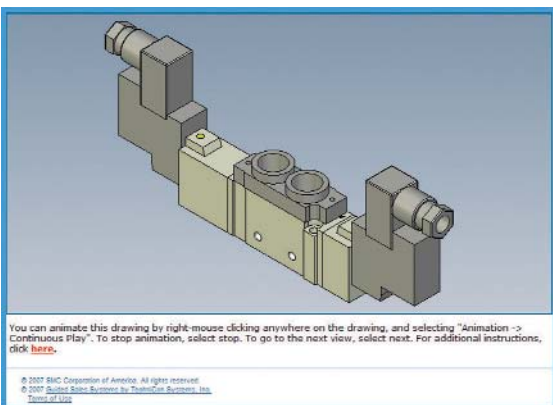
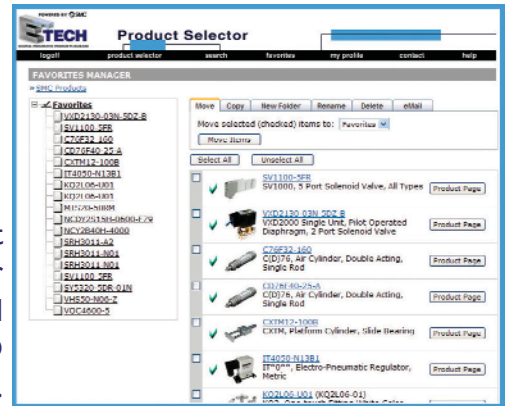

2D CAD interactive drawings.

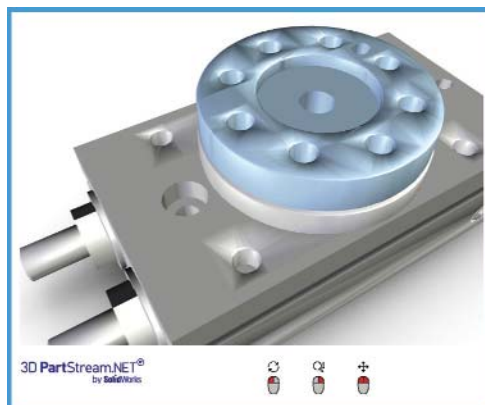

3D CAD model rendering.

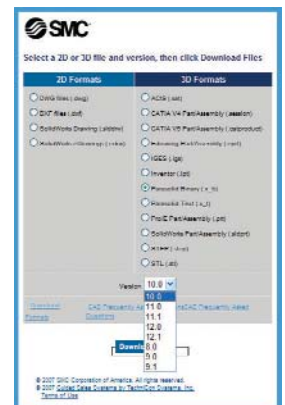

Choose from many CAD files to download.